

— CHELSOM —

EST. 1947

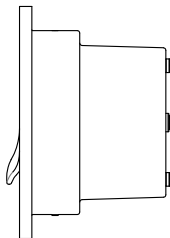
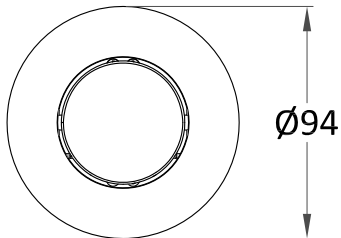
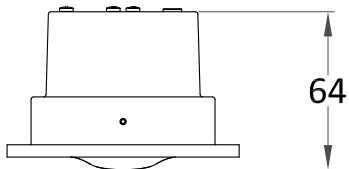
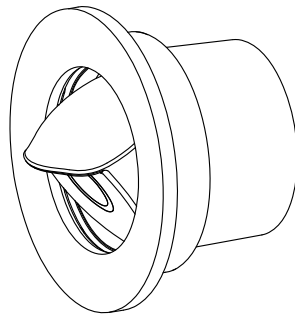

$\text{Ø}75$
Cutout In Headboard

SEE PAGE 3

$3 \times \text{Ø}3.5$

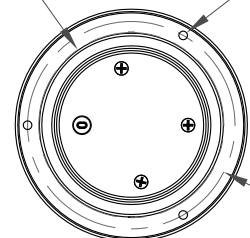

$\text{Ø}84$

— CHELSOM —

EST. 1947

FOLLOW THE NUMBERED ASSEMBLY SEQUENCE

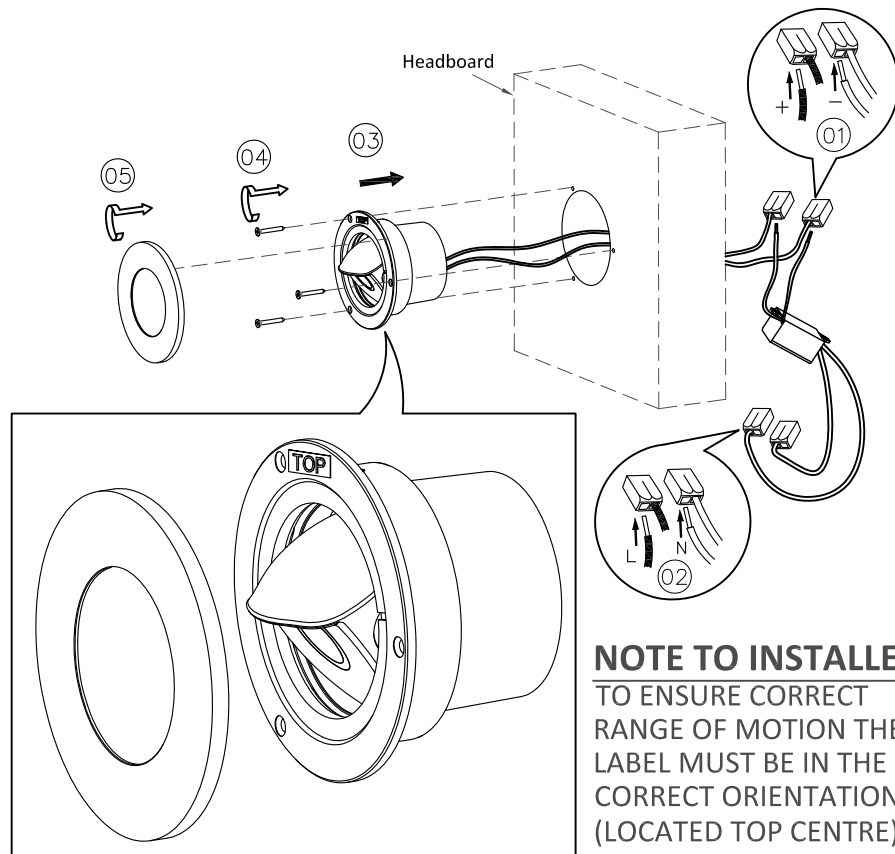

RANGE OF MOVEMENT

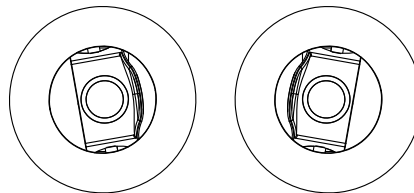
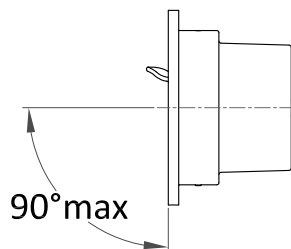

Left/right movement, max. 80° each way

SLR Information

This product contains a light source of Energy Efficiency Class E Regulation 2021 No. 1095

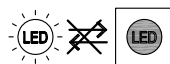

Non-replaceable light source

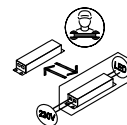

Control gear replaceable by qualified person

www.chelsom.co.uk