

# — CHELSOM —

EST. 1947

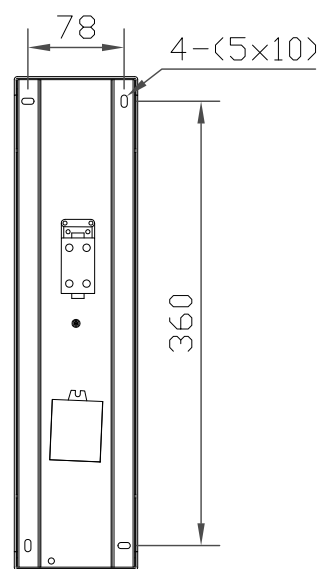
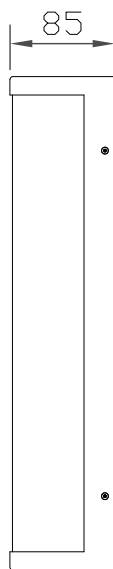
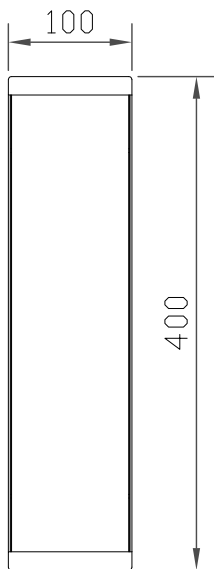
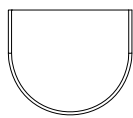
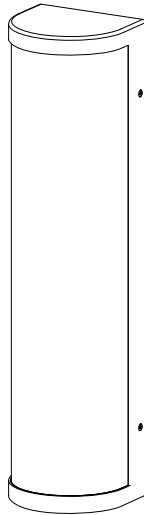

**VN/3/W1**

# — CHELSOM —

EST. 1947

FOLLOW THE NUMBERED ASSEMBLY SEQUENCE

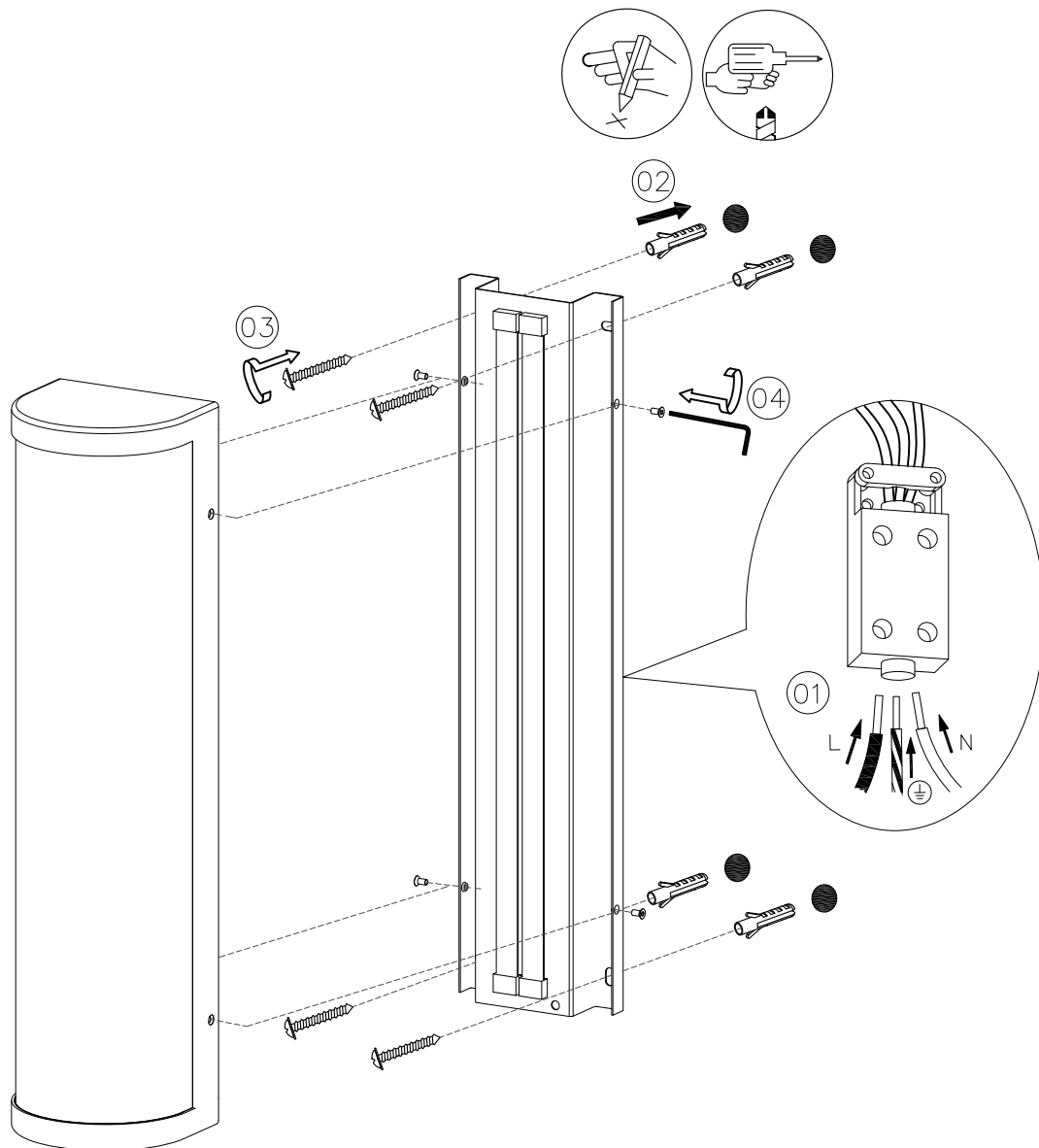

## SLR Information

This product contains a light source  
of Energy Efficiency Class E  
Regulation 2021 No. 1095

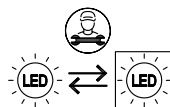

LED light source  
replaceable by  
qualified person

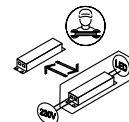

Control gear  
replaceable by  
qualified person

[www.chelsom.co.uk](http://www.chelsom.co.uk)