

— CHELSOM —

EST. 1947

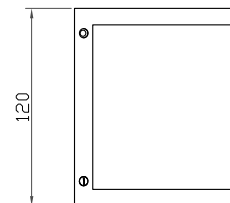
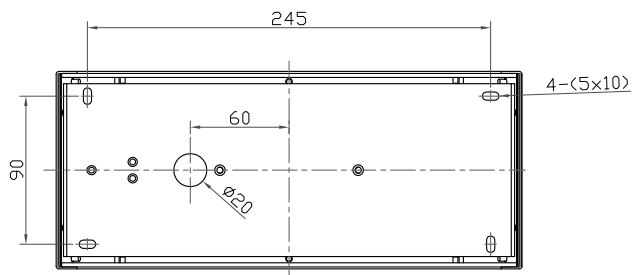
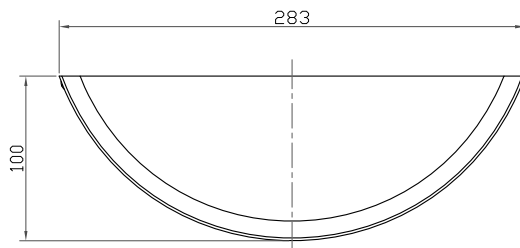
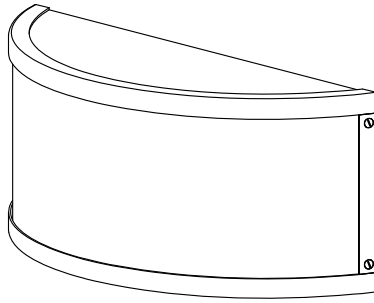

AD/35/WW

— CHELSOM —

EST. 1947

FOLLOW THE NUMBERED ASSEMBLY SEQUENCE

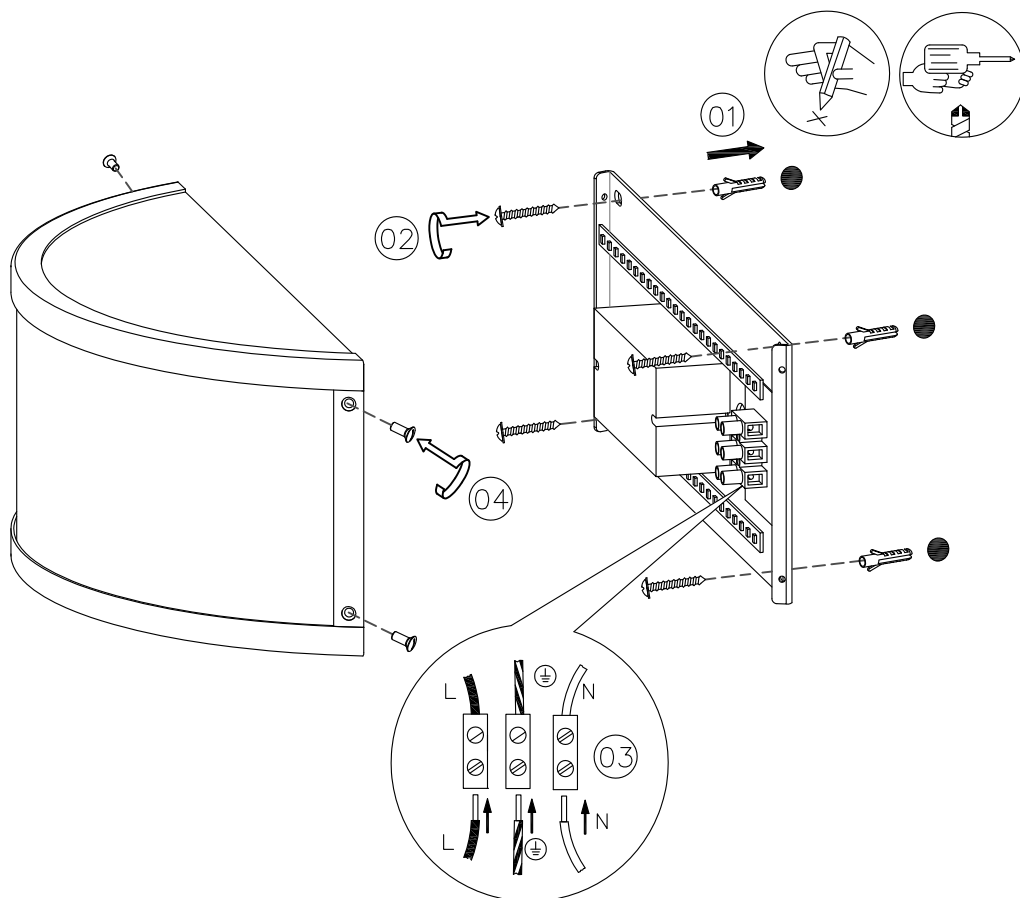

SLR Information

This product contains a light source of Energy Efficiency Class E Regulation 2021 No. 1095

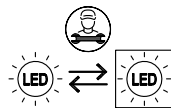

LED light source replaceable by qualified person

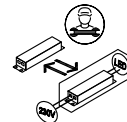

Control gear replaceable by qualified person

www.chelsom.co.uk