

# — CHELSOM —

EST. 1947

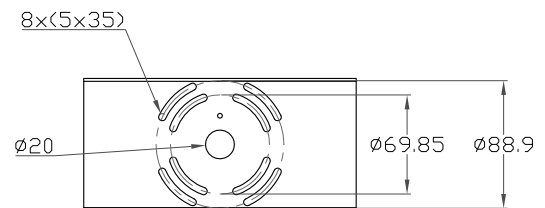
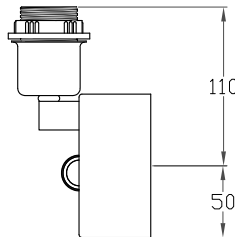
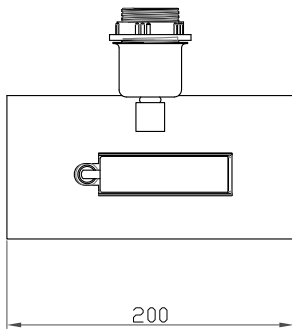
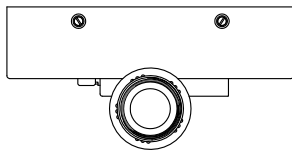
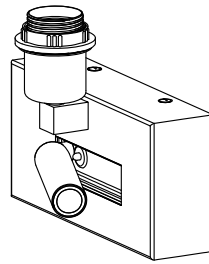

**LED/5/2/W1L**

**Revision A**

# — CHELSOM —

EST. 1947

FOLLOW THE NUMBERED ASSEMBLY SEQUENCE

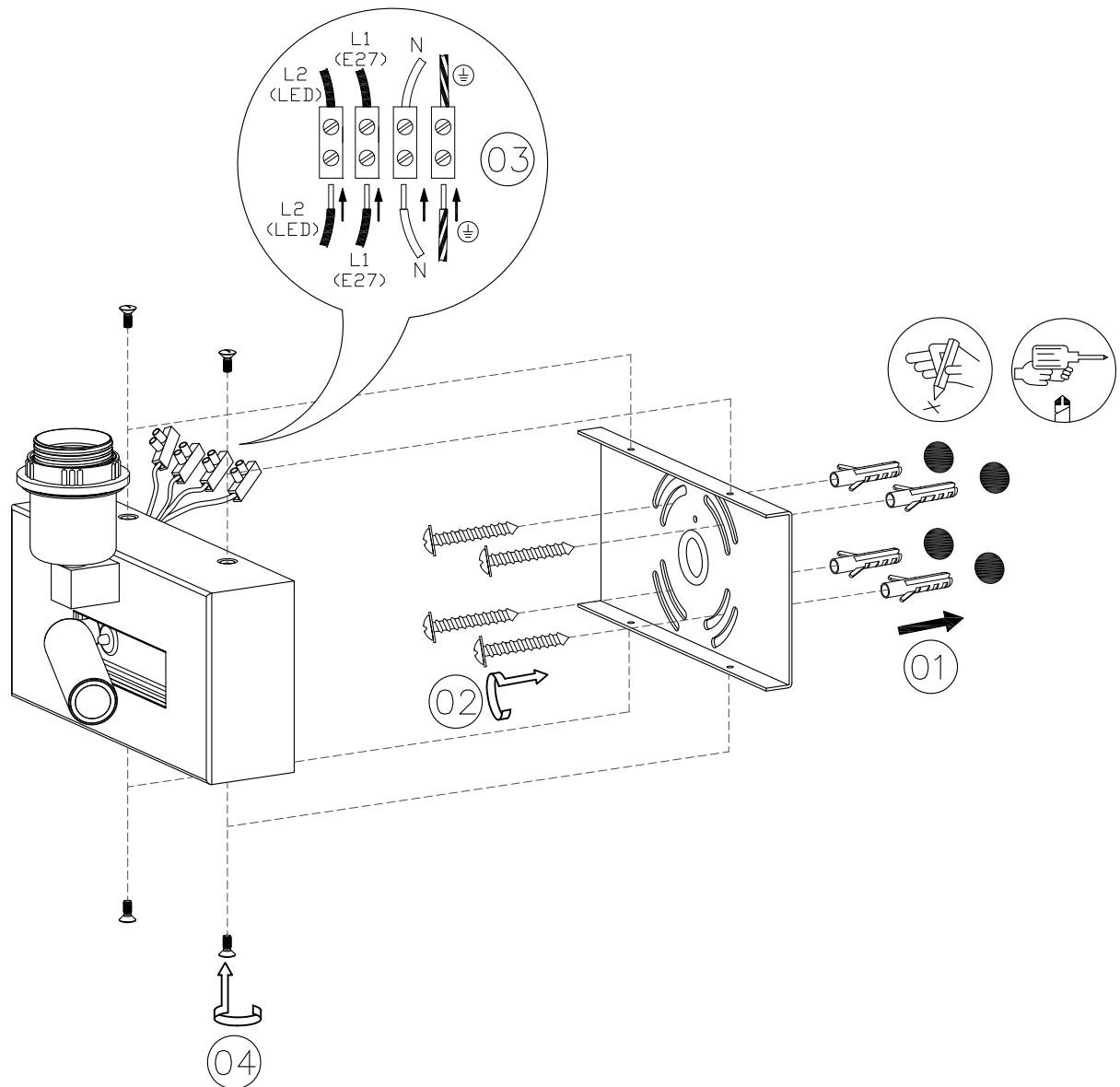

## SLR Information

This product contains a light source of Energy Efficiency Class E Regulation 2021 No. 1095

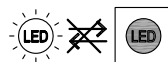

Non-replaceable light source

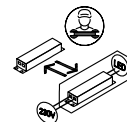

Control gear replaceable by qualified person