



FEATURES

LED DOCK COMBINATION WALL LIGHT - READING LIGHT HAS DOCKING SWITCH OPERATION. LEFT AND RIGHT HANDED AVAILABLE.

MATERIAL

STEEL AND ALUMINIUM

FINISH

BLACK BRONZE WITH ENGLISH BRASS (BB/EBR)

RECOMMENDED LAMP

1 X E27 7W LED 2700K PLUS 1 X LED 1W 2700K

CERTIFICATIONS

CE UK CA IP20

DIMENSIONS

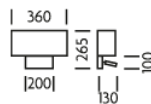

FULL TECHNICAL SPECIFICATION

MATERIAL	STEEL AND ALUMINIUM	DRIVER LOCATION	INTEGRAL
FINISH	BLACK BRONZE WITH ENGLISH BRASS (BB/EBR)	SWITCH TYPE	DOCKING SWITCH
LAMPHOLDER TYPE	E27 AND INTEGRAL LED	DIMMABLE AS STANDARD?	BY REQUEST ONLY
RECOMMENDED LAMP	1 X E27 7W LED 2700K PLUS 1 X LED 1W 2700K	INSULATION RATING	CLASS I
COLOUR TEMPERATURE	2700K	IP RATING	IP20
MAX WATTAGE (RETROFIT)	30W	PROJECTION	130MM
WATTAGE (W) - INTEGRAL LED	1W	BACKPLATE DIMENSIONS	100 X 200MM
CE	YES	NET PRODUCT WEIGHT	1KG
UKCA	YES	OVERALL HEIGHT AS SHOWN	265MM
UL	FOR UL PLEASE ENQUIRE.	OVERALL WIDTH AS SHOWN	360MM

FOR MORE INFORMATION ABOUT THIS PRODUCT:

Email: sales@chelsom.co.uk | Call: +44 (0)1253 831400

Chelsom Limited, Heritage House, Clifton Road, Blackpool, Lancashire FY4 4QA, United Kingdom

wordpress-700079-2614039.cloudwaysapps.com

— CHELSOM —

EST. 1947

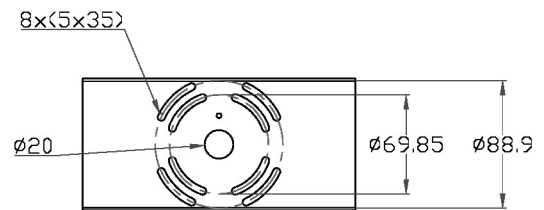
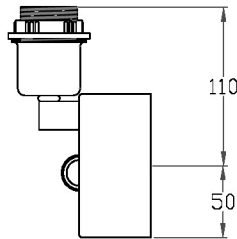
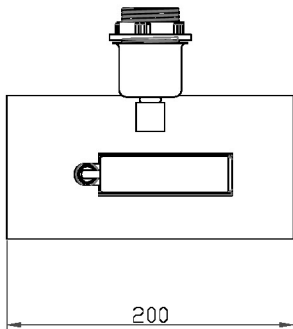
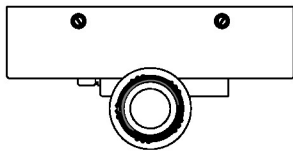
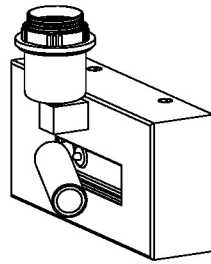

LED/5/2/W1L

Revision A

— CHELSOM —

EST. 1947

FOLLOW THE NUMBERED ASSEMBLY SEQUENCE

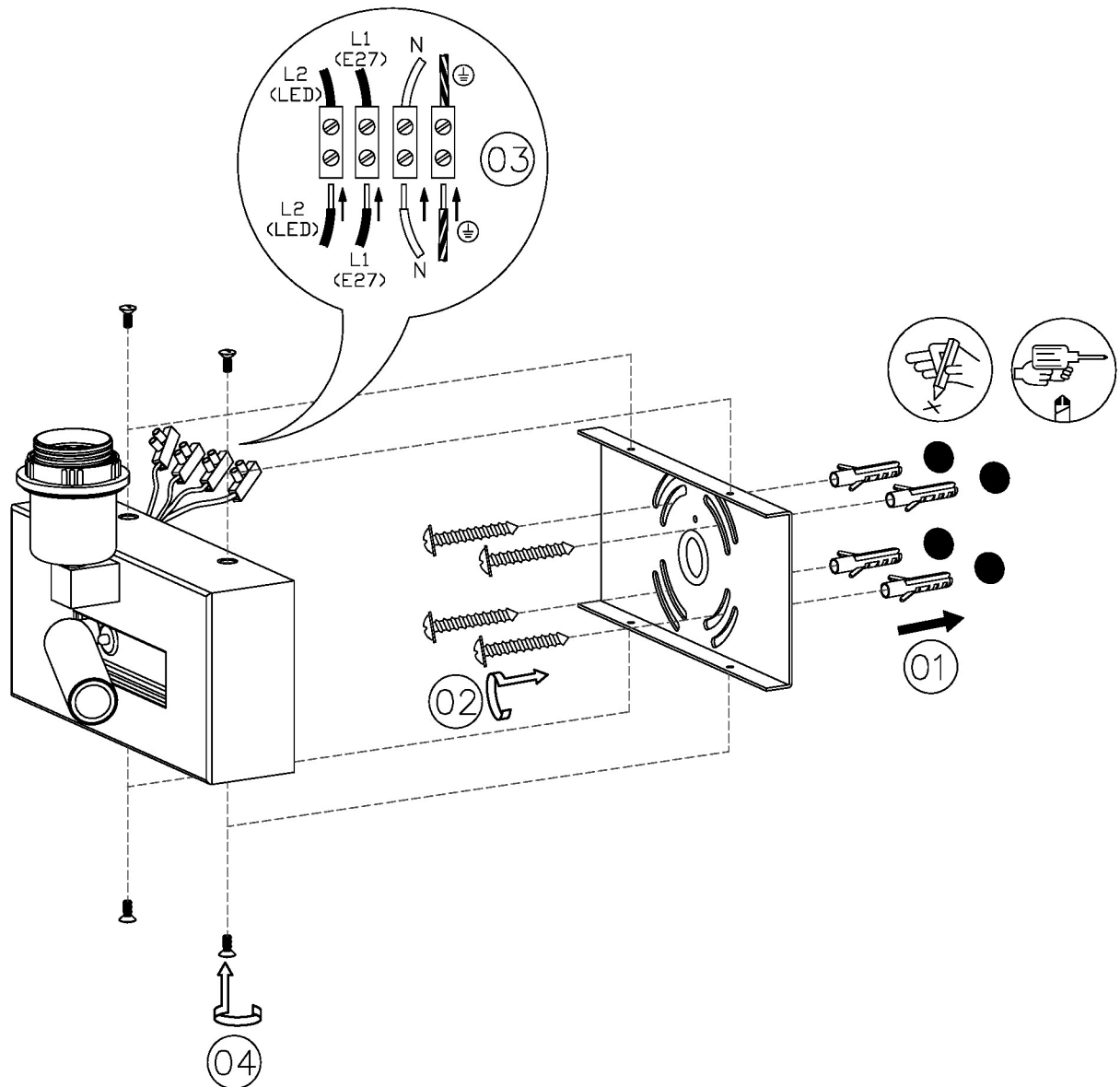

SLR Information

This product contains a light source of Energy Efficiency Class E Regulation 2021 No. 1095

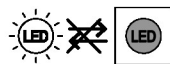

Non-replaceable light source

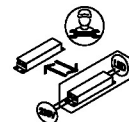

Control gear replaceable by qualified person

www.chelsom.co.uk